

NEC Display Solutions

Video Wall Installation Guide

Settings and Adjustments for MultiSync® UN552S | UN552VS | UN552 | UN552V | UN552A | UX552S | UX552 | UN492S | UN492VS | UN462A | UN462VA

A guide to trouble-free, efficient video wall installation

This guide will assist you in setting up your video wall quickly and correctly in order to benefit fully from the specially designed video wall features. Please read the instructions carefully and consider all the steps in order to achieve the best results.

Attention: For unboxing and physical monitor handling, please refer to the printed Installation Manual included in each display carton box.



AUTO SETUP Principle

Any input signal up to UHD resolution can be distributed across the video wall by using the Tile Matrix function. The UNxx2 displays provide several "AUTO SETUP" functions for simple and fast video wall setup and management. To enable these functions to operate correctly, it is necessary for DisplayPort, HDMI and LAN cables to be daisy chained as illustrated below.

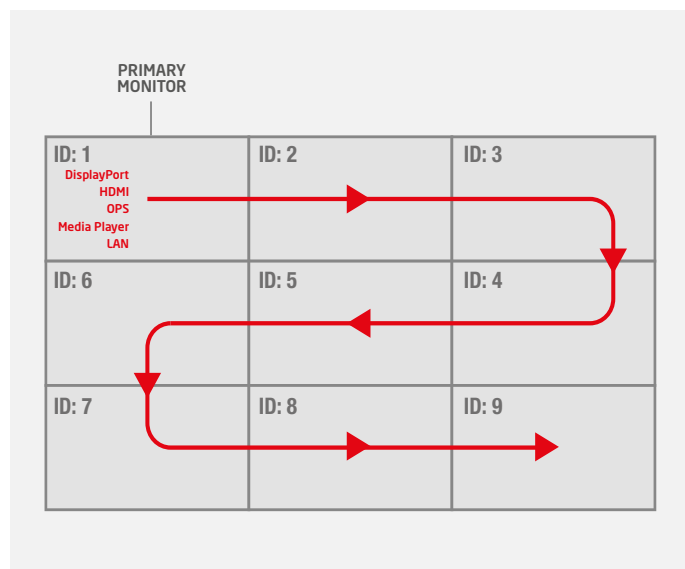

Primary monitor - input/output mapping

For uncompromising visual results, no signal conversion is necessary. Refer to the mapping table between input and output interfaces. Depending on the required input source, use HDMI and/or DisplayPort Daisy Chain cabling.

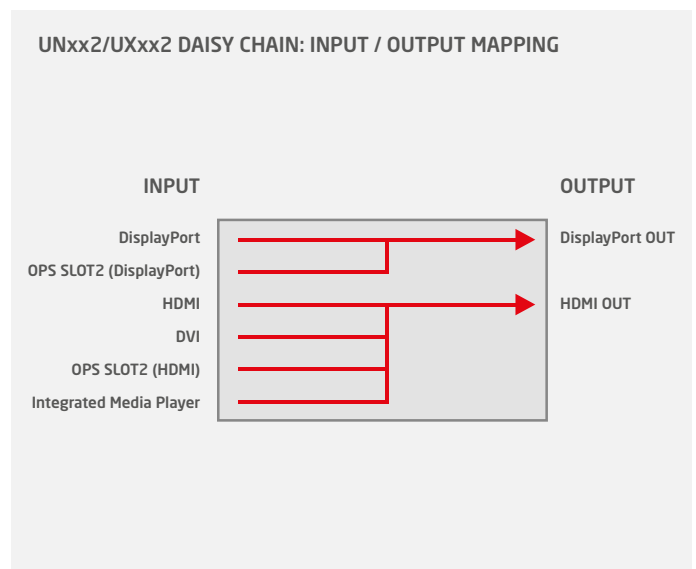

1. LAN cable Daisy Chain

Used for controlling monitors via network management system (e.g. NEC NaViSet Administrator 2), external remote kit KT-RC3 and for display calibration.

Note: LAN1: input, LAN 2: output. Alternatively, RS232 input can be used for the first monitor.

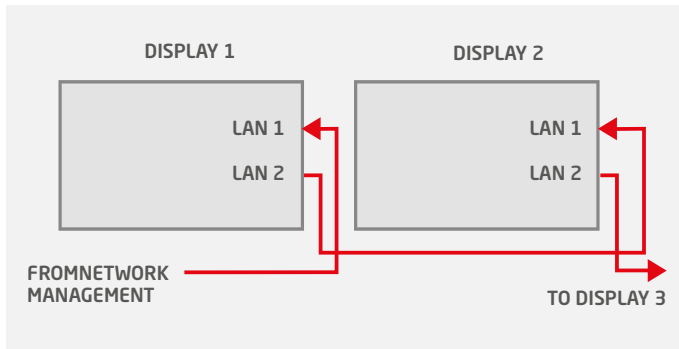

3. DisplayPort Daisy Chain

Used for forwarding video signals from the following sources: DisplayPort and OPS Slot-in PC.

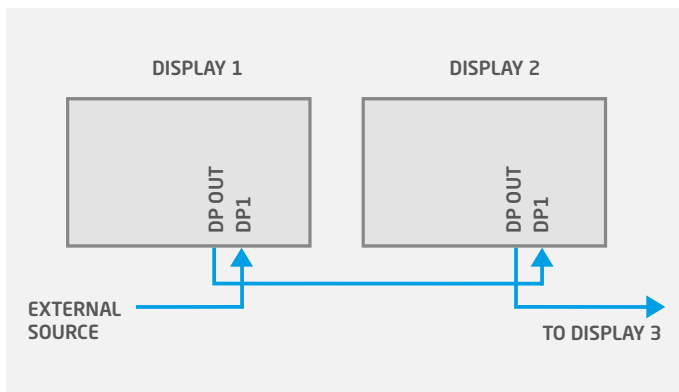

5. How to program the correct ID on the Remote Control

The Remote Control can be configured to manage a dedicated monitor or all monitors in parallel.

- All displays in parallel: Hold REMOTE ID SET (key bottom left) and press button “0”
- Dedicated display (e.g. Display 1): Hold REMOTE ID SET (key bottom left) and press button “1”



2. Connect remote IR sensor (KT-RC3)

Connect the sensor to the first screen in the LAN daisy chain using the supplied 3.5mm jack cable. (connect to interface “REMOTE” on the first screen)

Note: The sensor allows you to benefit from the ambient light sensor and the human sensor, it also serves as a conventional IR receiver enabling you to control the wall via the remote control. The KT-RC3 sensor kit, including remote control is sold separately.

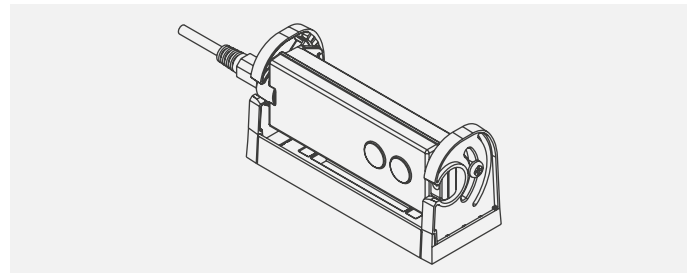

4. HDMI Daisy Chain

Used for forwarding video signals from the following sources: HDMI, DVI, internal Media Player and OPS Slot-in PC.

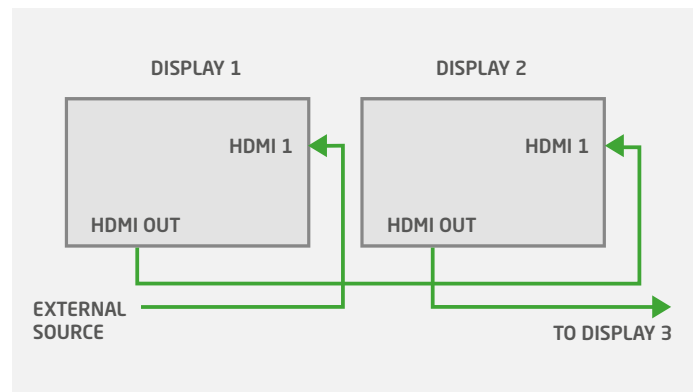

6. Connect an source to the primary monitor

Connect your external PC to the DisplayPort, HDMI or DVI interface on the first monitor. Alternatively, utilise an OPS Slot-in PC or the integrated Media Player embedded into the first monitor for a neat and seamless solution.

In the case of using OPS-PC as a source, the internal OPS-PC interface should be configured as “DisplayPort” to achieve the highest signal quality (3840 x 2160, 60 Hz).

The default setting is “AUTO” for highest compatible resolution.

For manual setup of the OPS-PC interface, use the remote control on the Primary Monitor:

- **Menu:** OPTION > SLOT2 CH SETTING > CH1 > SET
- **Menu:** OPTION > SLOT2 CH SELECT > DisplayPort > SET

7. IP Address assignment

There are two options, “Auto” or “Manual” for IP address assignment. For a fast initial video wall setup, it is recommended to use the Auto-IP functionality.

Note: When controlling the video wall via a network management system (e.g. NEC NaViSet Administrator 2), it is recommended to assign after setting up the video wall static IP addresses to each display, in order to ease LAN communication to the displays

9. Auto ID / IP SETTING

Setting the monitor ID / IP address for all monitors must be performed on the primary monitor.

Menu: MULTI-DSP > ID CONTROL > AUTO ID/IP SETTING > START > SET
Confirm number of detected monitors with “CONTINUE”
AUTO ID/IP > SETTING SETTING ITEM: ID and IP > SET

Note: The monitors’ ID and IP addresses are provided sequentially and automatically to each connected display.

ID: 1	192.168.10.1	ID: 2	192.168.10.2	ID: 3	192.168.10.3
ID: 6	192.168.10.6	ID: 5	192.168.10.5	ID: 4	192.168.10.4
ID: 7	192.168.10.7	ID: 8	192.168.10.8	ID: 9	192.168.10.9

11. Auto TileMatrix Setup

Auto-configuration to distribute the input signal to the entire video wall.

Menu: MULTI-DSP > AUTO TILE MATRIX SETUP >
set number of H MONITORS & V MONITORS > ACTIVATE > SET

Note: Requires cabling setup as described in section 1.

12. Choose visual application Pre Set

For a perfect visual result, the monitors feature a factory calibrated application Pre Set. Choose your preferred picture mode PRE-Set on the first screen.

Menu: PICTURE > PICTURE MODE > PRESET

Note: The SpectraView engine in each display guarantees that all displays pick up the same factory calibrated parameters, according to the chosen PRE-Set.

8. Auto ID / IP RESET

Monitor ID / IP address reset should be performed on the first monitor.

Menu: MULTI-DSP > ID CONTROL > AUTO ID/IP RESET > SET

Note: Auto ID Reset must be performed on the first monitor in the LAN daisy chain when configuration, cabling or monitors are changed or swapped.

10. Chose input source for all displays

To distribute the video signal from primary monitor across all monitors, each monitor must have DisplayPort or HDMI as input.

Configure the remote control as ID „0“ to manage all screens in parallel (refer to section 5)

POWER ON the entire video wall (some of the displays may be in auto-standby during configuration).

Choose the preferred INPUT source (DisplayPort or HDMI) for all displays via the input buttons on the remote control.

Note: In the case of an OPS Slot-in PC or Media Player input, the first monitor must be switched to Option or Media Player. In this case, all other monitors in the Daisy Chain remain DisplayPort or HDMI. For a detailed Daisy Chain cable mapping table, refer to the chapter “Primary monitor - input/output mapping” at the beginning of this guide.

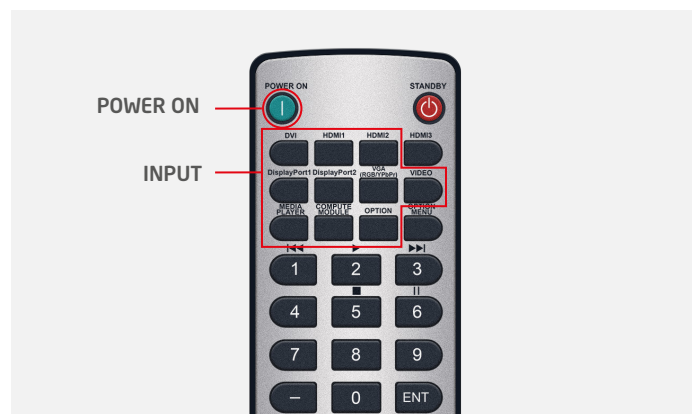

13. Copy Settings (Picture settings)

To align all monitors within the video wall with the same application Pre Set of the first screen, copy the chosen settings to all monitors.

Menu: MULTI-DSP > SETTING COPY

Select “PICTURE” > SET

COPY START > YES

Additional PC-less advanced calibration capabilities

PC-less display Self-Calibration

Through self-calibration, each monitor adjusts its settings according to the factory calibrated LUT, managed by the inbuilt SpectraView engine. PC-less calibration uses an MDSV Sensor 3 directly connected to the dedicated monitor's USB interface.

Connect the MDSV Sensor 3 to the display monitor's USB1 (SENSOR) interface.

Menu: PICTURE > SPECTRAVIEW ENGINE > CALIBRATION > SET STAND-ALONE CALIBRATION > SELF CALIBRATION > SET

Note: For proper handling, this feature is recommended for video walls of up to 3x3 displays, depending on accessibility. For most efficient handling, larger video walls should be calibrated via the PC-based **Display Wall Calibrator** application.

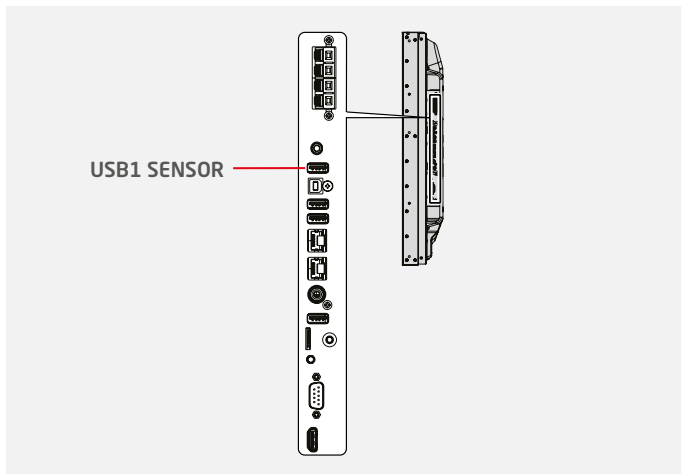

PC-less White Copy function

Using the self-calibration feature, settings from a reference display are copied to each dedicated display in the video wall. Connect a MDSV Sensor 3 to the USB interface of the display to be adjusted. Using the sensor, measure a white test pattern on the reference display to readjust the display calibration.

Connect the MDSV Sensor 3 into the USB1 (SENSOR) interface of the display to be adjusted.

Place the sensor on the reference monitor showing a white test pattern.

Menu: PICTURE > SPECTRAVIEW ENGINE > CALIBRATION > SET STAND-ALONE CALIBRATION > WHITE COPY > SET

Note: To perform White Copy, self-calibration must be completed beforehand. For proper handling, this feature is recommended for video walls of up to 3x3 displays, depending on accessibility. For most efficient handling, larger video walls should be calibrated via the PC-based **Display Wall Calibrator** application.

Display Wall Calibrator application high-end adjustment capabilities

In addition to the extensive calibration capabilities, two new high-end adjustment features lift the video wall calibration result to a new outstandingly high level. For further details please refer to the **Display Wall Calibrator** application users manual.

Corner Uniformity Correction

To perform the corner colour matching on a single monitor.

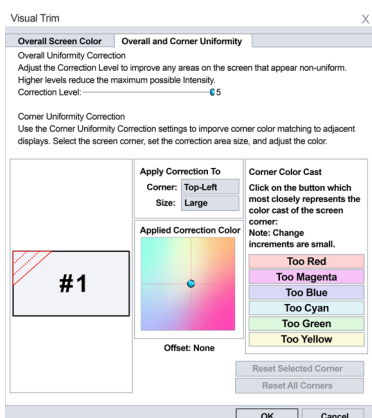

Uniformity Correction

To perform internal screen uniformity on a display, up to 10x10 measurement points can be defined within one monitor.

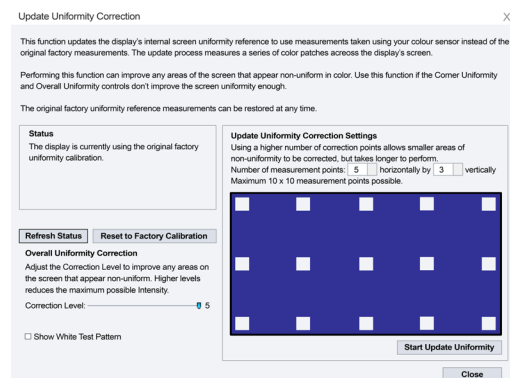

Additional useful settings and application

FRAME COMP and REVERSE SCAN

To compensate for the vertical image shift often visible in fast moving pictures between Daisy Chained monitors, FRAME COMP or REVERSE SCAN function can be selected in the OSD.



WITHOUT
FRAME COMP



WITH
FRAME COMP

NFC: Intelligent Wireless Data

NFC supports pre-configuration of the display settings or access to status information even when the monitor is not powered, using the NFC based “intelligent Wireless Data” Android app. Pre-configuration of the monitor OSD settings can be performed easily before the displays are mounted. All major functions can be preset by using an Android device equipped with an NFC chip.

NaViSet Administrator 2

The all-in-one software enables IT administrators to remotely manage their network of NEC display devices and Windows PCs. In multi-device environments, this system simplifies the handling and control of devices helping to keep maintenance costs low, minimise downtime and ensure the efficient use of resources.



NEC Display Solutions Europe GmbH
Landshuter Allee 12-14, D-80637 München
infomail@nec-displays.com
Phone: +49 (0) 89 99 699-0
Fax: +49 (0) 89 99 699-500
www.nec-display-solutions.com